

ARTIFICIAL NEURAL NETWORK MODEL FOR ANALYSIS OF ELLIPTICAL MICROSTRIP PATCH ANTENNA

RAKESH KUMAR MAURYA¹, AJAY KUMAR MAURYA² & RABINDRA KUMAR SINGH³

¹Faculty of Engineering and Technology, MJP Rohilkhand University, Bareilly, Uttar Pradesh, India

²UNSIIT, Veer Bahadur Singh, Purvanchal University, Jaunpur, Uttar Pradesh, India

³Kamala Nehru Institute of Technology, Sultanpur, Uttar Pradesh, India

ABSTRACT

In this paper a new technique is proposed to calculate design parameters of Elliptical micro-strip patch antenna using Artificial Neural Networks (ANN) for circular polarization. Training data is collected from HFSS Ansoft Simulator. ANN models are developed to calculate the antenna parameters, for the given resonant frequency, aspect ratio, dielectric constant and height of substrate. The Levenberg-Marquardt (trainlm) algorithm, with multilayer perceptron (MLP) feed forward back propagation (FFBP) network is trained to achieve an accurate model. The model is then validated by comparing with the simulated and measurement. The design model is very useful for computer aided design (CAD), antenna engineers and other similar applications.

KEYWORDS: ANN, Microstrip Antenna, Resonant Frequency, FFBNN, HFSS Simulation

INTRODUCTION

In modern communication systems like cellular phones, personal computer cards for wireless local area network; micro strip antenna is preferred as compare to other radiators. Micro strip patch antennas are low profile, conformable to planar and non-planar surfaces, and can be easily fabricated using printed circuit board technology. They are also mechanically robust when mounted on rigid surfaces, and compatible with Monolithic microwave integrated circuit (MMIC) designs. These patch antennas are used for high performance spacecraft, aircraft, missile and satellite applications, where size, weight, cost, performance, ease of installation, and aerodynamic profile are constraints.

When a particular patch shape and excited mode are selected, they are very versatile in terms of resonant frequency, polarization, radiation pattern, and impedance. In this work Elliptical micro strip patch antennas (EMSA) are the ones under consideration as their geometry presents greater potentials for a variety of electrically small low-profile antenna applications. The elliptical shape has several advantages like providing larger flexibility in the design, more degrees of freedom compared to the circular geometry and circular polarization is achieved with single feed. Elliptical patch geometry is perhaps least analyzed regular shape geometry due to involvement of Mathieu's and modified Mathieu's function in mathematical analysis.

The involvement of these functions makes mathematics of elliptical patch geometries extremely difficult. There are various methods available for the calculation of resonant frequency for elliptical patch antenna. These methods obtain resonant frequency for even (f_e) and odd (f_o) modes as the function of input variables, which are the height of the dielectric substrate (h), dielectric constant (ϵ_r), and antenna dimensions (the major axis and the minor axis). But reverse

calculation of the antenna dimensions from the inputs like frequencies (f_e, f_o), height (h) and dielectric constant (ϵ_r) is not available in the literature. In this paper, the antenna dimensions are determined by using Artificial Neural Networks. ANN design aims at utmost simplicity and self-organization. In the present paper feed forward back propagation neural network (FFBPNN) are used and the Leven Berg-Marquardt training algorithm is used to train the feed-forward Back Propagation (FFBP) network. The FFBPNN train with Levenberg- Marquardt (L-M) training algorithm is one of the approaches which show a great promise in this sort of problems because of its faster learning capacity.

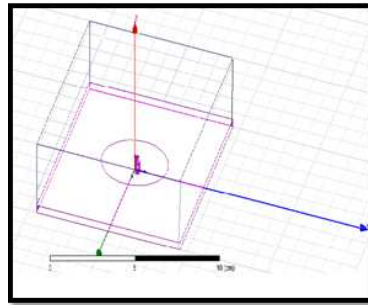

Figure 1: HFSS Designed Basic Model of Elliptical Microstrip Antenna

THEORY OF ELLIPTICAL MICROSTRIP ANTENNA

Elliptical patch antenna is shown in Figure 1, where a is the semi major axis, b is the semi minor axis and a_{eff} is the effective semi-major axis. The feed position is located along the 45° line between the major and minor axis of the elliptical patch. The radiated fields cause two modes that are perpendicular to each other and have equal amplitude, but are 90° out of phase. An elliptical patch antenna with optimum dimensions acts as a Circular Polarized wave radiator [2].

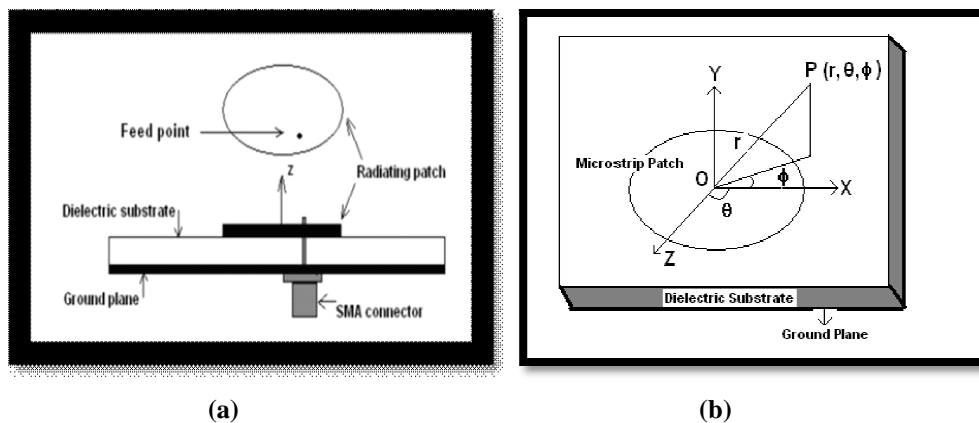

Figure 2: Elliptical Microstrip Patch Antenna for Circular Polarization

The patch is excited by a coaxial probe extending through the ground plane and contacting the patch as is shown in Figure 1. The empirical formulas for calculation of dual resonance frequency using approximated Mathieu function [1-3] are listed below.

Effective Semi Major Axis

$$a_{eff} = a \left[1 + \left(\frac{2h}{a\pi\epsilon_r} \right) \left\{ \ln \left(\frac{a}{2h} \right) + (1.41\epsilon_r + 177) + \frac{h}{a} (0.268\epsilon_r + 1.65) \right\} \right]^{1/2} \quad (1)$$

Even Mode Resonance Frequency

$$f_{11} = \frac{15}{\pi e a_{eff}} \sqrt{\frac{q_{11}}{\epsilon_r}} \quad (2)$$

$$q_{11} = -0.0049e + 3.788e^2 - 0.7278e^3 + 2.314e^4 \quad (3)$$

Odd Mode Resonance Frequency

$$f_{11} = \frac{15}{\pi e a_{eff}} \sqrt{\frac{q_{11}}{\epsilon_r}} \quad (4)$$

$$q_{11} = -0.0063e + 3.8613e^2 - 1.3151e^3 + 5.2229e^4 \quad (5)$$

Where

a – Semi-major axis

h – Height of dielectric substrate

ϵ_r – Permittivity of dielectric substrate

a_{eff} – Effective semi-major axis

e – Eccentricity of elliptical patch

f_{11}^{eo} – Dual-Resonance frequency

q_{11}^{eo} – Approximated Mathieu function of the dominant (TM_{11}^{eo}) mode

CONVENTIONAL ELLIPTICAL PATCH ANTENNA

In this study, first a conventional elliptical patch microstrip antenna, of semi-major and semi-minor axes of length a and b , respectively, has been considered. The patch is considered lying in XY plane over a large ground plane with substrate thickness ($h \ll \lambda_0$), substrate dielectric constant (ϵ_r) and relative permeability ($\mu_r = 1$) as shown in Figure 2 (a).

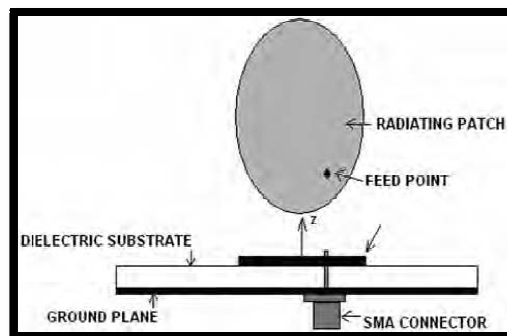

Figure 3: Geometry and Feed Arrangement of Conventional Elliptical Patch Antenna

The magnetic field in such structure has essentially x and y components. Because $h \ll \lambda_0$, the fields do not vary along the z-direction and the component of the current normal to the edge of the microstrip antenna approaches to zero at the edges. With these assumptions, this elliptical structure can be considered as a cylindrical resonator with magnetic sidewalls, bounded at its top and bottom by electric walls. In the designed structure, length of semi-major and

semi Minor axes are $a = 1.7\text{cm}$, $b = 1.41\text{cm}$, respectively with eccentricity $e = 0.558$. The structure has been designed on glass epoxy FR4 substrate having substrate thickness $h = 0.33\text{ cm}$, substrate relative permittivity $\epsilon = 4.5$ and loss tangent $\tan \alpha = 0.0011$. The simulation analysis has been carried out by applying IE3D simulation software¹⁴ while experimental work has been carried out at ISAC; Bangalore by using the available facilities. The simulation analysis reveals that in the range of 1-3.5 GHz, antenna resonates at a single resonance frequency 2.25 GHz corresponding to its dominant mode as shown in Figure 2. The measured resonance frequency of this antenna as shown in same figure is 2.261 GHz, which is in close agreement with the simulated frequency. The impedance bandwidth corresponding to 10 dB return loss is 58 MHz. The following figure shows the resonant frequency curve.

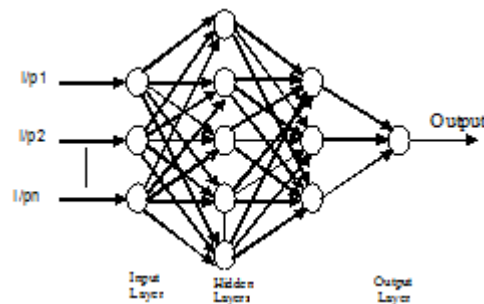

Figure 4: FFBP Network Structure

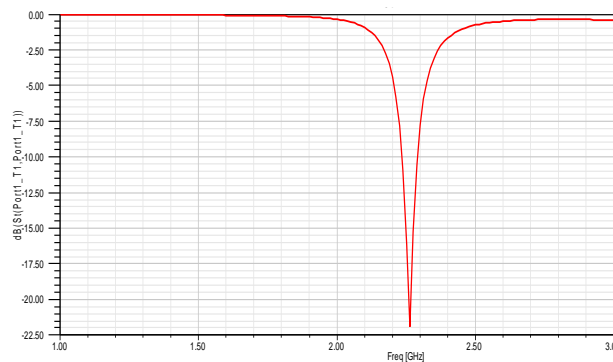

Figure 5: Resonant Frequency Curve

ANN MODELING

FFBPNN has three layers of neurons, namely input, hidden and output, which are fully interconnected as shown in Figure 2. The input layer consists of just the inputs to the network. The number of nodes, n is equal to the dimension of input vector $X = (x_1, x_2, \dots, x_n)$. Then follow a hidden layer, which consist of any number of neuron. Each neuron performs a weighted summation of the inputs, which then passes a nonlinear activation function σ , also called the *neuron* function. The nonlinear activation function σ here we used is Hyperbolic tangent sigmoid transfer function (i.e. tansig)

$$\text{tansig}(n) = 2/(1+\exp(-2*n)) - 1$$

In order to design FFBPNN, network weights are to be found. Finding the weights is called network training. The Levenberg-Marquardt training algorithm is used to train the feed-forward Back Propagation (FFBP) network. The training process requires a set of examples of proper network behavior network inputs P and target outputs T . The FFBPNN has to be trained with the input data $P = (X_1, X_2, \dots, X_N)$ and the targets $T = (t_1, t_2, \dots, t_N)$. During training the weights and biases of the network are iteratively adjusted to minimize the network performance function

(i.e. mean squared error). By using set of input-output pairs, called training set, the network parameters are optimized in order to fit the network targets to the given inputs. After training, the FFBP network can be used with data whose underlying statistics is similar to that of the training set, known as testing set. A trained neural network can be used for high-level design, providing fast and accurate answers to the task it has learned.

In this paper FFBPNN is built to obtain antenna dimensions from the function of input variables, which are resonant frequency (f_e), the height of the dielectric substrate (h), dielectric constants of the dielectric material (ϵ_r) and the eccentricity of elliptical patch (e) as shown in Figure 3.

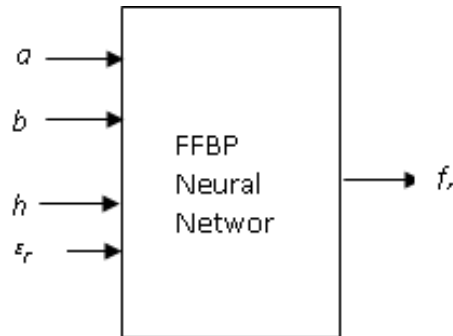

Figure 6: FFBPNN Model for EMSA

RESULTS AND ANALYSIS

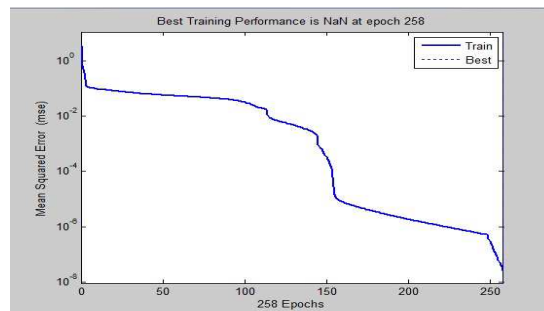

Figure 7: ANN Training Performance

Table 1: Data's from HFSS

Patch No.	Major Axis(a) cm	Minor Axis(b) cm	Substrate Height(h) cm	Relative Permittivity	Resonant Frequency (GHz)
1	2.5	1.92	0.34	2.55	2.799
2	2.6	2.0	0.35	2.55	2.734
3	2.7	2.07	0.36	2.55	2.649
4	2.8	2.15	0.37	2.55	2.548
*5	2.9	2.23	0.38	2.55	2.477
6	2.1	1.5	0.33	3.5	2.757
7	2.2	1.57	0.42	3.5	2.610
8	2.5	1.78	0.45	3.5	2.323
9	2.4	1.71	0.48	3.5	2.397
*10	2.5	1.78	0.37	3.5	2.346
11	2.8	1.86	0.37	4	1.834
12	2.9	1.93	0.41	4	1.723
13	1.8	1.2	0.42	4	2.148

Table 1: Contd.,

14	1.5	1.0	0.45	4	2.50
15	1.2	0.8	0.48	4	2.985
*16	1.1	0.73	0.5	4	3.199
17	1.7	1.41	0.33	4.5	2.261
18	1.5	1.25	0.35	4.5	2.491
19	2.2	1.83	0.39	4.5	2.610
20	2.5	2.08	0.42	4.5	2.321
*21	2.7	2.25	0.45	4.5	2.109
22	2.5	1.56	0.34	6	2.948
23	2.7	1.68	0.35	6	1.473
24	2.6	1.62	0.36	6	2.842
25	2.2	1.37	0.37	6	3.309
*26	2.1	1.31	0.38	6	3.486
27	2.5	1.47	0.34	10	2.224
28	2.6	1.53	0.35	10	1.046
29	2.4	1.41	0.36	10	2.296
30	2.3	1.35	0.37	10	2.371
*31	2.2	1.29	0.38	10	2.484
32	2.3	1.77	0.33	10.2	2.946
33	2.2	1.69	0.34	10.2	3.061
34	2.1	1.61	0.35	10.2	2.498
35	2.0	1.53	0.36	10.2	1.273
*36	1.9	1.46	0.37	10.2	3.46

*tested Data Sets

Table 2: Comparison between ANN, HFSS and Theoretically Measured Output Data

Patch No.	HFSS Outputs	ANN Outputs	Theoretically Measured Data
1	2.799	2.799	2.7
2	2.734	2.734	2.8
3	2.649	2.649	2.66
4	2.548	2.548	2.5
5	2.477	2.47	2.4
6	2.757	2.757	2.66
7	2.610	2.610	2.59
8	2.323	2.323	2.4
9	2.397	2.397	2.3
10	2.346	2.36	2.28
11	1.834	1.834	1.81
12	1.723	1.723	1.7
13	2.148	2.148	2.49
14	2.50	2.50	2.55
15	2.985	2.985	2.99
16	3.199	3.189	3.0
17	2.261	2.261	2.32
18	2.491	2.491	3.44
19	2.610	2.610	2.7
20	2.321	2.321	2.39
21	2.109	2.105	2.19
22	2.948	2.948	2.88
23	1.473	1.473	1.41
24	2.842	2.842	2.79
25	3.309	3.309	3.38

Table 2: Contd.,

26	3.486	3.466	3.4
27	2.224	2.224	2.2
28	1.046	1.119	1.2
29	2.296	2.296	2.0
30	2.371	2.371	2.4
31	2.484	2.47	2.52
32	2.946	2.946	2.99
33	3.061	3.061	3.12
34	2.498	2.498	2.5
35	1.273	1.273	1.29
36	3.46	3.453	3.47

CONCLUSIONS

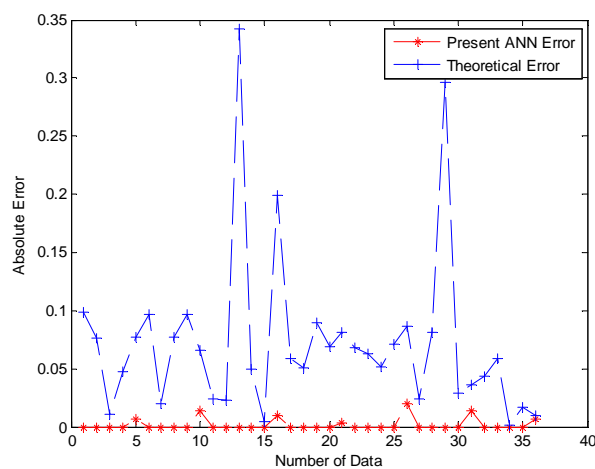

Figure 8: Error Presentation

The results obtained by using FFBPNN for elliptical microstrip patch antennas are in good agreement with available targeted results as compare to results calculated from theoretical approach. Figure 8 shows the present ANN error and theoretical error. The proposed network requires less training time and is more accurate in prediction. Figure 7 shows the ANN Training performance. Using these FFBPNN models, various possible dimensions can be obtained to achieve high bandwidth and single feed circular polarization. ANN models are simple, easy to apply and very useful for antenna engineers to predict both patch dimensions and resonant frequency.

REFERENCES

1. N. Kumprasert, "Theoretical study of dual resonant frequency and circular polarization of elliptical microstrip antennas", *IEEE AP-S International Symposium*, vol. 2, 1015-1020, July 2000.
2. S. A. Long, L. C. shen, D. H. Schaubert, and F. G. Farrar, "An experimental study of the circular polarized elliptical printed-circuit antenna", *IEEE Trans. Antennas Propag.*, vol. AP-29, No. 1, 95- 99, January 1981.
3. P. Mythili, and A. Das, "Simple approach to determine resonant frequencies of microstrip antennas", *IEE proc. Microw. Antennas Propag.*, vol. 145, No. 2, 159-162, April1998.
4. A. Mishra, G. B. Janvale, B. V. Pawar, and P. M. Patil, "The design of circular microstrip patch antenna by using quasi-Newton algorithm of ANN", *J. Electromagnetic Analysis & Application*, vol. No. 2, 444-449, July 2010.

5. Qi-Jun Zhang, Kuldip C. Gupta, and Vijay K. Devabhaktuni, "Artificial Neural Networks for RF and Microwave Design: From Theory to Practice", *IEEE Trans. Microwave theo. Andtechn.*, vol. 51, No. 4, 1339-1350, April 2003.
6. XU Wen-shang, YU Zing-ming, SUN Yan-liang, and DONG Tian-wen, "Research on Improving Speed of LMBP algorithm and Its Simulation in Application", *International. Conf. on Comp. Intell. and Security*, 540-545, Dec. 2007.
7. P. Mythili, and Raj Kumar, "On the Design of Multilayer Circular Microstrip Antenna using Artificial Neural Networks", *International Journal of Recent Trends in Engineering*, vol.